



# **ATLAS Router User Manual**

**Part Number 1200263L1-1.2A**



901 Explorer Boulevard  
P.O. Box 140000  
Huntsville, AL 35814-4000  
(256) 963-8000

© 1998 ADTRAN, Inc.  
All Rights Reserved.  
Printed in U.S.A.

# Table of Contents

---

<b>List of Figures</b> .....	<b>v</b>
<b>Chapter 1. Router</b> .....	<b>1-1</b>
Router Overview .....	1-1
Features .....	1-2
Specifications .....	1-2
<b>Chapter 2. Technology Overview</b> .....	<b>2-1</b>
IP Routing .....	2-1
<b>Chapter 3. Operation</b> .....	<b>3-1</b>
Overview .....	3-1
Terminal Menu Structure .....	3-1
Router Menu .....	3-2
IP Menu .....	3-3
Static Routes .....	3-3
ARP Cache .....	3-4
Routes .....	3-5
Interfaces .....	3-7
<b>Chapter 4. Configuration Overview and Examples</b> .....	<b>4-1</b>
Example 1: IP Routing Network—ATLAS as the Central-Site Router .....	4-2
<b>Appendix A. Glossary</b> .....	<b>A-1</b>
<b>Index</b> .....	<b>Index-1</b>



# List of Figures

---

Figure 1-1. External Routers .....	1-1
Figure 1-2. Internal Routers .....	1-2
Figure 3-1. Router Added to the Main Terminal Menu .....	3-1
Figure 3-2. Router Menu Tree .....	3-2
Figure 3-3. IP Routes Menu .....	3-3
Figure 3-4. Static Routes Menu .....	3-3
Figure 3-5. ARP Cache Menu .....	3-4
Figure 3-6. Routes Menu .....	3-5
Figure 3-7. Interfaces Menu .....	3-7
Figure 4-1. ATLAS Configured for the Router Option.....	4-1
Figure 4-2. IP Routing Network with ATLAS as the Central-Site Router .....	4-2
Figure 4-3. Panel for Creating Packet Endpoint .....	4-2
Figure 4-4. Panel for Creating Sublinks .....	4-3
Figure 4-5. Panel for Connecting IP Traffic to Internal Router .....	4-3
Figure 4-6. Panel for Connecting Endpoints to Physical Interface .....	4-4
Figure 4-7. Panel for Enabling Routing.....	4-4



**ROUTER OVERVIEW**

The ATLAS router uses the integral 10BaseT Ethernet port to transmit local area network (LAN) traffic over the wide area network (WAN) to a remote LAN. By integrating the router into the network access device, you benefit from the cost savings of not requiring an external router. Figure 1-1 and Figure 1-2 illustrate a conversion from an application with external routers to one using integral routers within ADTRAN products.

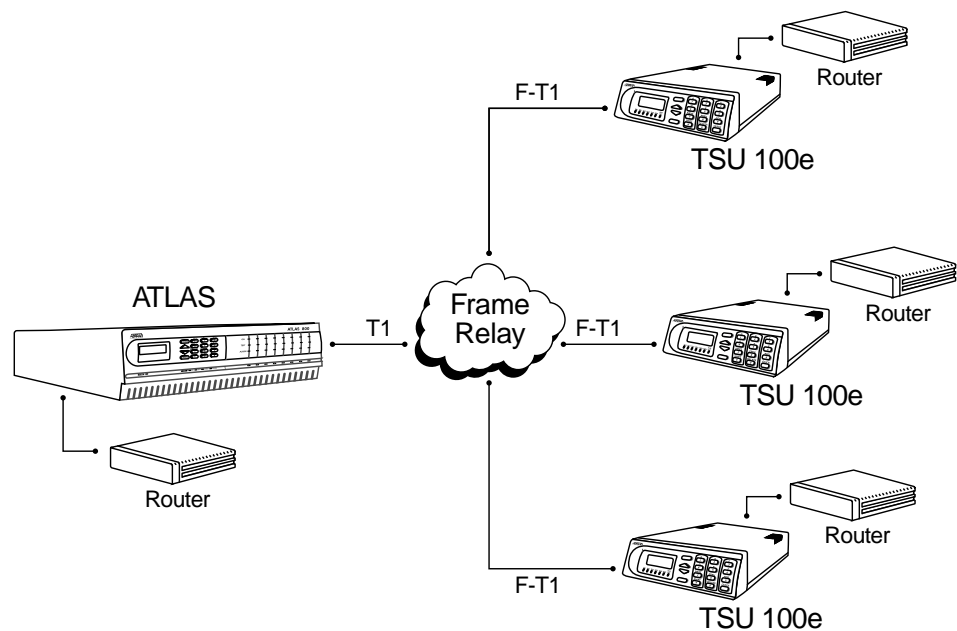

**Figure 1-1. External Routers**

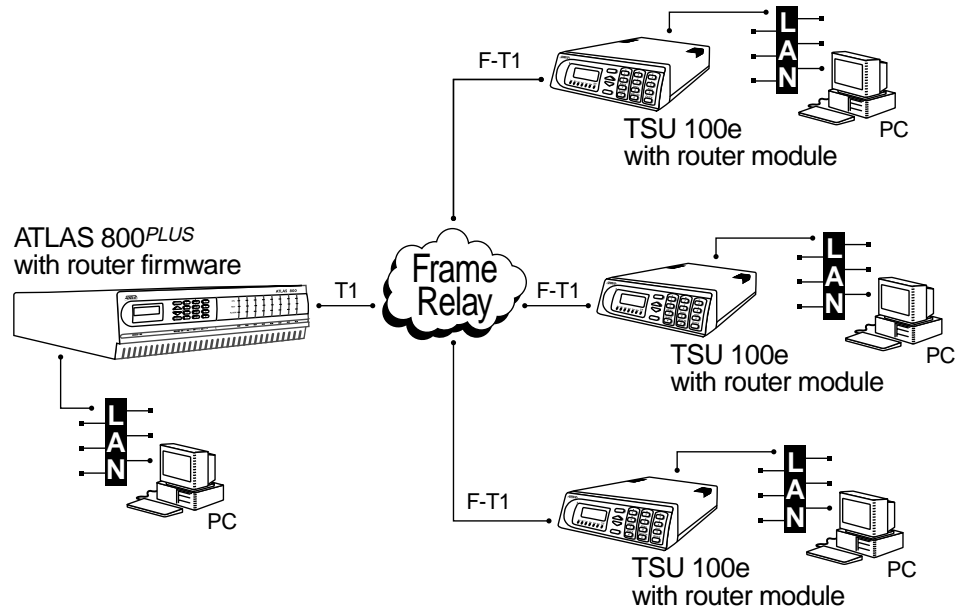

**Figure 1-2. Internal Routers**

The Frame Relay/Router option lets the ATLAS series of Integrated Access Devices act as a voice/data FRAD, a frame relay switch, and an IP router—in addition to the currently available bandwidth management and switch applications.

## FEATURES

The Router option provides the following features:

- Routes IP traffic between a public or private frame relay network and the integral 10BaseT Ethernet port.
- Routes IP traffic between virtual circuits in a frame relay network.

## SPECIFICATIONS

IP Routing	
Route Discovery	RIP V1 RIP V2 ICMP DHCP ARP IARP UDP Relay



**IP ROUTING**

Internet Protocol (IP) routing is performed at layer 3 of the Open System Interconnection (OSI) model. (Refer to the *Frame Relay User Manual* for a description of the OSI model.) The routing process determines the optimal path for data packets to travel and then moves the data packets along that path. Routers exchange information about paths or routes that reach additional LAN segments. This exchange of routing information allows a router to build a detailed knowledge of the network topology. Criteria for selecting the best path can include such items as distance, number of hops (servers or routers), and cost of the transportation media.

ATLAS supports Routing Information Protocol (RIP), a protocol based on hops. Each route has a set number of hops (routers or servers) that it must travel through to reach a final destination. If a new route to a host address that has a fewer number of hops is learned, it becomes the preferred route. When a new route is learned, the router increments the hop count by one and immediately broadcasts the new route over the other interfaces. To prevent routing loops, RIP defines a hop count of 16 as an infinite or unreachable route.



## OVERVIEW

The Router Upgrade provides remote connectivity of LANs within an ATLAS—from LAN-to-WAN connection or from WAN-to-WAN connection. The Router Upgrade is included as part of the frame relay upgrade and includes an IP Router.

## TERMINAL MENU STRUCTURE

The ATLAS uses hierarchical menus to access all of its features. The top-most menu level leads to submenus which are grouped by functionality. All menu items display in the terminal window.

**NOTE** Refer to the ATLAS User Manual for detailed instructions on how to navigate through the terminal menu.

When the Router Option is enabled, the *Router Menu* is added to the main terminal menu (see Figure 3-1). All routing functions within ATLAS are configured and monitored from the *Router Menu*.

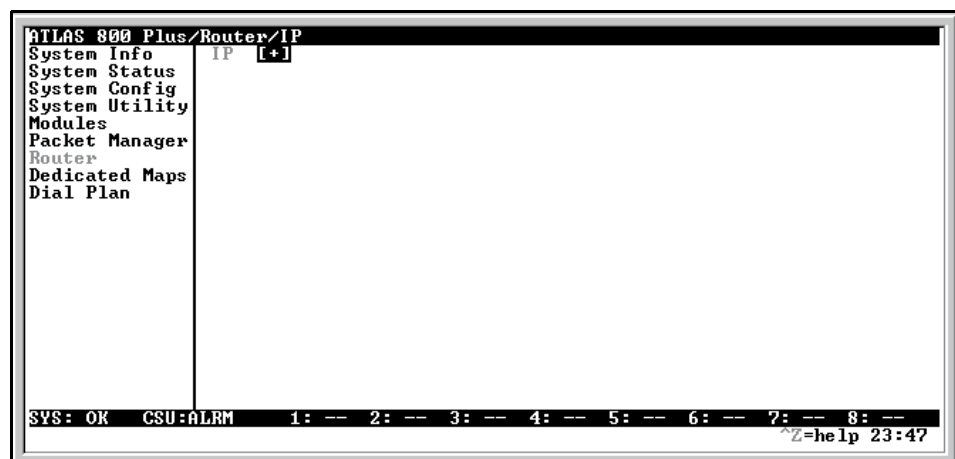

```
ATLAS 300 Plus/Router/IP
System Info IP [+1]
System Status
System Config
System Utility
Modules
Packet Manager
Router
Dedicated Maps
Dial Plan

SYS: OK CSU:ALRM 1: -- 2: -- 3: -- 4: -- 5: -- 6: -- 7: -- 8: --
^Z=help 23:47
```

**Figure 3-1. Router Added to the Main Terminal Menu**

## ROUTER MENU

The Router Menu defines, configures, and monitors all ATLAS Router options. Figure 3-2 displays the IP Router menu tree.

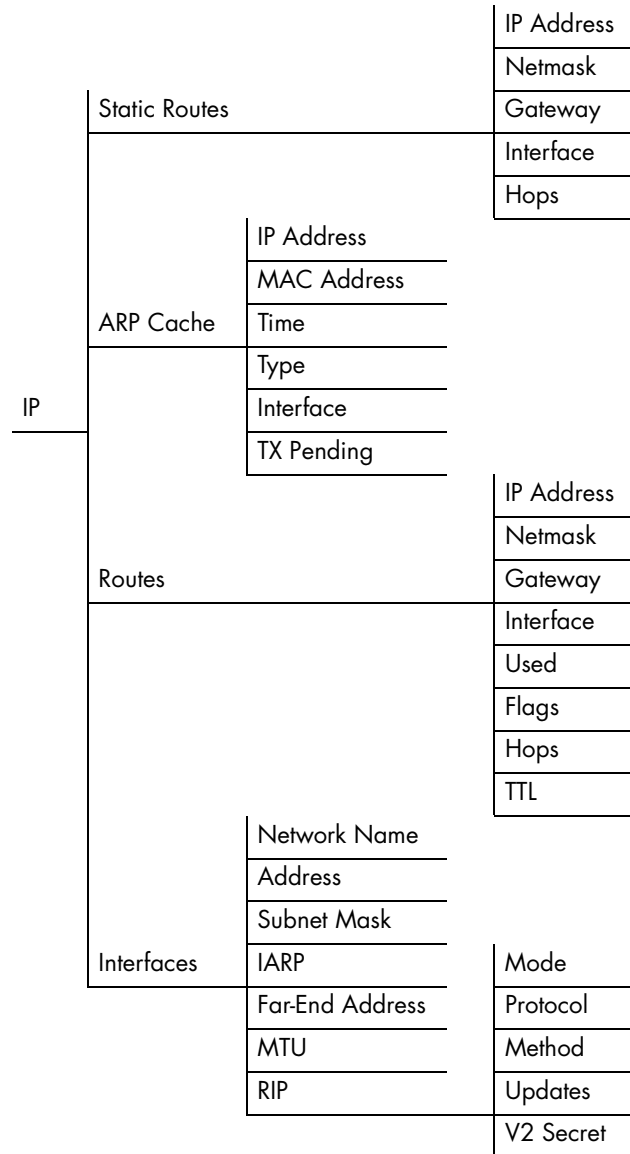

**Figure 3-2. Router Menu Tree**

## IP MENU

The IP Menu defines and monitors IP routes (see Figure 3-3).

```

ATLAS 800 Plus/Router/IP
IP Static Routes [+1]
  ARP Cache [+1]
  Routes [+1]
  Interfaces [+1]

SYS: OK CSU:ALRM 1: -- 2: -- 3: -- 4: -- 5: -- 6: -- 7: -- 8: --
^Z=help 23:50_

```

Figure 3-3. IP Routes Menu

## Static Routes

The *Static Routes* Menu manages static IP routes. You can create, modify, and delete routes using this menu (see Figure 3-4).

```

ATLAS 800 Plus/Router/IP/Static Routes[1]
Static Routes
ARP Cache 1
Routes
Interfaces

IP Address      Netmask      Gateway      Interface Ho
1 172.16.5.0    255.255.255.0 172.16.5.208 Local

SYS: OK CSU:ALRM 1: -- 2: -- 3: -- 4: -- 5: -- 6: -- 7: -- 8: --
INS/DEL ^Z=help 23:59

```

Figure 3-4. Static Routes Menu

### IP Address

Write Security: 3; Read Security: 5

Defines the IP address of the host or network device being routed to.

### Netmask

Write Security: 3; Read Security: 5

Determines for routing the number of bits used in the above-defined IP address. If a host address is desired for the IP address, this field must be set to 255.255.255.255.

**Gateway**

Write Security: 3; Read Security: 5

Defines the IP address of the router to receive the forwarded IP packet.

**Interface**

Write Security: 3; Read Security: 5

Defines the interface to which IP packets with this address will be routed. These are either Ethernet or frame relay DLCIs.

**Hops**

Write Security: 3; Read Security: 5

Defines the number of router hops required to get to the network or host. Maximum distance is 15 hops.

**ARP Cache**

The ARP Cache Menu displays the contents of the ATLAS Address Resolution Protocol (ARP) cache (see Figure 3-5). All resolved cache entries time out after 20 minutes. Unresolved entries time out in 3 minutes.

ATLAS 300 Plus Router/IP/ARP Cache							
Static Routes		IP Address	MAC Address	Time	Type	Interface	ix
ARP Cache	1	172.16.5.211	00:00:00:00:00:00	0	Dynam	ni_local	3
Routes	2	172.16.5.208	00:00:00:00:00:00	2	Dynam	ni_local	0
Interfaces	3	172.16.5.254	00:00:0C:07:AC:04	0	Dynam	ni_ip0	0

SYS: OK CSU:ALRM 1: -- 2: -- 3: -- 4: -- 5: -- 6: -- 7: -- 8: --  
INS ^Z=help 0:03

**Figure 3-5. ARP Cache Menu****IP Address**

Read Security: 5

Displays the IP address used for resolving MAC address.

**MAC Address**

Read Security: 5

Resolves Ethernet address. If set to all zeros, there is no resolution for that address.

**Time**

Read Security: 5

Displays the minutes since the entry was last referenced.

**Type**

Write Security: 3; Read Security: 5

Defines this entry as dynamic or static.

**Interface**

Read Security: 5

Displays the interface upon which this entry was found.

**Tx Pending**

Read Security: 5

Displays the number of transmit packets pending a reply.

**Routes**

The *Routes* Menu displays the contents of the ATLAS route table. All static and discovered routes are displayed from this menu (see Figure 3-6).

The screenshot shows the ATLAS 800 Plus Router's IP/Routes menu. The menu is titled 'ATLAS 800 Plus Router/IP/Routes' and has a left-hand navigation pane with options: 'Static Routes', 'ARP Cache', 'Routes', and 'Interfaces'. The 'Routes' option is selected. The main display area shows a table of static routes with the following columns: 'IP Address', 'Netmask', 'Gateway', and 'Interface'. The table contains seven entries, numbered 1 through 7. At the bottom of the screen, there is a status bar with the text 'SYS: OK CSU:ALRM' and a row of indicators for ports 1 through 8, all of which are currently inactive (indicated by dashes). A help prompt 'Z=help 0:01\_' is visible in the bottom right corner.

	IP Address	Netmask	Gateway	Interface	Us
1	127.0.0.1	255.255.255.255	127.0.0.1	Local	
2	224.0.0.9	255.255.255.255	224.0.0.9	Local	
3	200.100.101.255	255.255.255.255	200.100.101.7	Local	
4	200.100.101.0	255.255.255.255	200.100.101.7	Local	
5	200.100.101.7	255.255.255.255	200.100.101.7	Local	
6	200.100.101.0	255.255.255.0	200.100.101.7	EN0 IP	
7	255.255.255.255	255.255.255.255	255.255.255.255	Local	

**Figure 3-6. Routes Menu****IP Address**

Read Security: 5

Displays the IP address of the network or host destination address.

**Netmask**

Write Security: 3; Read Security: 5

Displays the netmask applied to the destination address.

**Gateway**

Read Security: 5

Displays the IP address of the host or router receiving the forwarded IP packet.

### **Interface**

Read Security: 5

Displays the interface to which IP packets with this address will be routed.

### **Options**

Local	Sent directly to the ATLAS router
ENO IP	ATLAS Ethernet port
Endpoint Name	(DLCI #)

### **Used**

Read Security: 5

Displays the number of times the router has referenced this route.

### **Flags**

Read Security: 5

Indicates the properties of this routing table entry, composed of the following letters:

- H** - route is a host route
- G** - route is a gateway route
- D** - route learned dynamically from RIP
- I** - route learned from an ICMP redirect
- P** - route is private and is not advertised with RIP
- T** - route is to a triggered port (updated only when table changes)

### **Hops**

Read Security: 5

Displays the number of router hops required to get to the network or host.

Ranges from 0 to 16. If set to 16, it is defined as infinite and cannot be routed.

### **TTL**

Read Security: 5

Displays the number of seconds until the address is removed from table. Value of 999 means the route is static.



## Interfaces

The *Interfaces Menu* (see Figure 3-7) configures and monitors all interfaces connected to the ATLAS router. These include the Ethernet and frame relay DLCIs connected in the *Packet Manager/ Packet Cncts.*

Network Name	Address	Subnet Mask	IARP	Far-End
1 EN0 IP	200.100.101.3	255.255.255.0		

**Figure 3-7. Interfaces Menu**

### Network Name

Read Security: 5

Displays the name of the interface connected to the ATLAS router. The options are listed below:

- EN0 IP**            ATLAS Ethernet port
- Endpoint Name** (DLCI #)

### Address

Write Security: 3; Read Security: 5

Defines the individual interface IP address. If this field is left as 0.0.0.0, it is treated as an unnumbered interface.

### Subnet Mask

Write Security: 3; Read Security: 5

Defines the subnet mask applied to the address defined for this link. If the subnet mask is unnumbered, leave as 0.0.0.0.

**IARP** (Inverse ARP)

Write Security: 3; Read Security: 5

The Inverse ARP (IARP) field is only present when this is a frame-relay network interface. ATLAS always responds to Inverse ARP requests with its IP address for the requested DLCI.

**Enable** Atlas sends Inverse ARP packets in order to determine the IP address on the other end of the virtual circuit. If the Inverse ARP packet is responded to, a route is placed in the IP route table. When this field is set to ENABLE, ATLAS dynamically sends Inverse ARP packets to determine the IP address on the other end of the virtual circuit. When an Inverse ARP packet is not responded to, a route is placed in the IP route table.

**Disable** ATLAS responds to Inverse ARP requests with its IP address for the requested DLCI. If set to *DISABLE*, ATLAS does not generate Inverse ARP request packets. In this case, the *Far-End Address* parameter may be used to statically assign a route address (see *Far-End Address* on page 3-8).

**Far-End Address**

Read Security: 3; Write Security: 5

The Far-End IP Address field is only present for frame-relay network interfaces, and it is only selectable when Inverse ARP is disabled. The IP address of the device on the other end of the virtual circuit may be specified. A static route to the far-end network will be added using the interface *Subnet-Mask* if nonzero. If 0.0.0.0 has been specified for the *Subnet-Mask*, a default subnet mask is used based on the class of the Far-End Address. (See also *Subnet Mask* on page 3-7.)

**MTU** (Maximum Transmit Unit)

Read Security: 5

Defines maximum number of bytes in a datagram transmitted over this interface.

**RIP** (Routing Information Protocol)

Configures RIP on this interface.

**Mode**

Write Security: 3; Read Security: 5

Allows RIP to be enabled or disabled on a per-interface basis.

**Tx Only** RIP advertisements are periodically transmitted, but are not listened to on this virtual circuit.

**Rx Only** RIP advertisements are not transmitted on this virtual circuit, but they are listened to.

**Tx and Rx** RIP advertisements are periodically transmitted and are listened to on this virtual circuit.



**NOTE** If mode is Off, the following menus will **not** be visible.

**Protocol**

Write Security: 3; Read Security: 5

Sets the version of RIP being used on this interface. The options are RIP V1 and RIP V2.

 **NOTE** *If RIP V2 is used, a user-defined secret will have to be created.*

### **Method**

Write Security: 3; Read Security: 5

Defines the method used to send RIP route advertisements. The options are listed below:

<b>None</b>	All routes in the router table are advertised through this interface with no modification of the routing metric.
<b>Split Horizon</b>	Only advertises routes not learned through this interface.
<b>Poison Reverse</b>	All routes are advertised, but the routes learned through this interface are "poisoned" with an infinite route metric.

### **Updates**

Write Security: 3; Read Security: 5

Defines when RIP advertisements are transmitted.

<b>Periodic</b>	RIP advertisements are periodically transmitted.
<b>Triggered</b>	RIP advertisements are transmitted only when new routes are learned, and learned routes do not age.

### **V2 Secret**

Write Security: 3; Read Security: 5

Defines the secret used to advertise routes when using RIP V2.

 **NOTE** *This menu item is visible only if RIP V2 is used.*



# Chapter 4 Configuration Overview and Examples

This chapter provides several step-by-step examples to help you configure your ATLAS. Figure 4-1 illustrates an ATLAS configured for the Router option.

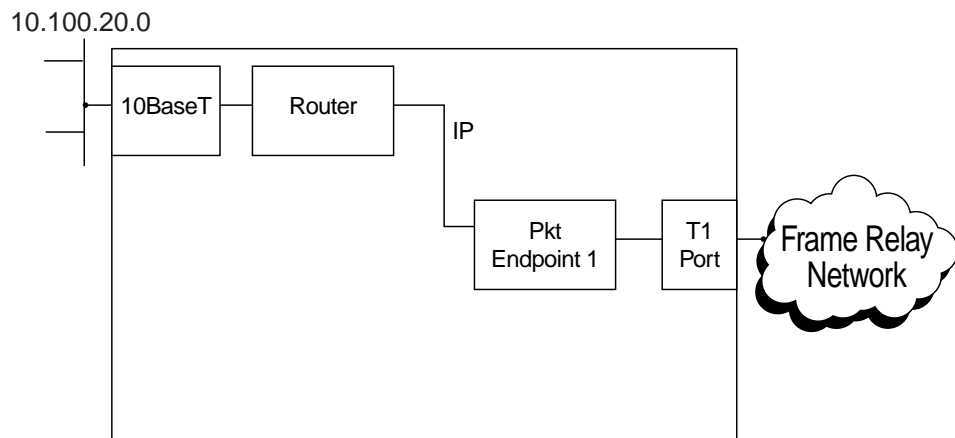

**Figure 4-1. ATLAS Configured for the Router Option**

The general procedure for configuring the ATLAS depicted in Figure 4-1 is as follows:

1. From *Packet Manager/Packet Endpnts/Config*, create the frame relay packet endpoint. Refer to the *Frame Relay User Manual* for more information.
2. From *Packet Manager/Packet Endpnts/Config/Sublinks*, create the necessary PVCs.
3. From *Packet Manager/Packet Cncts*, connect the frame relay endpoint to the Router.
4. From *Dedicated Map*, connect the frame relay packet endpoint to the appropriate physical interface.
5. From *Router/IP/Interfaces*, enable routing on the interface.
6. (Optional) Configure any static routes that might be required.

Specific configuration examples included in this chapter are as follows:

- IP Routing Network—ATLAS as the Central-Site Router . . . . . pg. 4-2

## Example 1: IP Routing Network—ATLAS as the Central-Site Router

Example 1 (see Figure 4-2) depicts a typical IP routing network using an ATLAS as the central-site router. (This ATLAS unit is the ATLAS 800<sup>PLUS</sup> with a frame relay upgrade.) The central-site ATLAS terminates a full T1 (F-T1) frame relay connection from the XYZ service provider, and the internal router terminates the IP traffic. A TSU 100e with a router module is located at each of the two remote sites. To re-create this example, follow the five-step process discussed below.

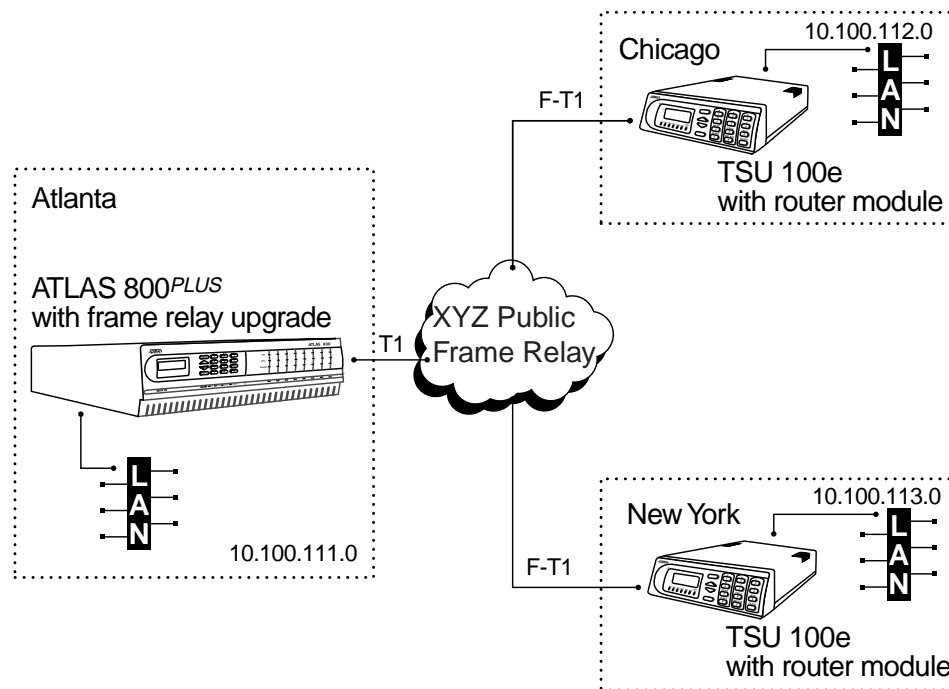

**Figure 4-2. IP Routing Network with ATLAS as the Central-Site Router**

### Step 1: Create the packet endpoint.

See Figure 4-3.

```

ATLAS 800 Plus/Packet Manager/Packet Endpnts/Config[1]
Status      Endpnt Name      Protocol  Config  Sublinks  Usage
Performance 1 XYZ Network    Frame Relay [+]  [+]  -----
Config
Test
SYS: OK  CSU:ALRM  1: --  2: --  3: --  4: --  5: --  6: --  7: --  8: --
INS/DEL      ^Z=help  0:35

```

**Figure 4-3. Panel for Creating Packet Endpoint**

**Step 2: Create the sublinks or DLCIs for frame relay.**

See Figure 4-4.

Config	Name	DLCI	QOS	Config
1	Chicago	102	768	[+]
2	New York	103	768	[+]

SYS: OK CSU:ALRM 1: -- 2: -- 3: -- 4: -- 5: -- 6: -- 7: -- 8: -- Z=help 0:17\_

**Figure 4-4. Panel for Creating Sublinks****Step 3: Connect the IP traffic to the internal router.**

See Figure 4-5.

Packet Cncts	FROM: Lnk	Circ. ID	TO: Lnk	Circ. ID	Protocol	Config
1	Fr:XYZ Ne	Chicago	Router	Not used	IP	N/A
2	Fr:XYZ Ne	New York	Router	Not used	IP	N/A

SYS: OK CSU:ALRM 1: -- 2: -- 3: -- 4: -- 5: -- 6: -- 7: -- 8: -- Z=help 0:49\_

**Figure 4-5. Panel for Connecting IP Traffic to Internal Router**

**Step 4: Connect packet endpoint to the appropriate physical interface.**

See Figure 4-6.

```

ATLAS 800 Plus/Dedicated Maps/Create/Edit Maps[1]/Connects
Connects
Enbl Day  # FROM Slot  Port  From Config  TO Slot/S  Prt/Lnk  To Config  RBS
          1  0>Sys C  1>T1/PR  [DS0=1]  PktLink  Fr:XYZ  [*]

SYS: OK  CSU:ALRM  1: --  2: --  3: --  4: --  5: --  6: --  7: --  8: --
                                     ^Z=help  0:51_

```

**Figure 4-6. Panel for Connecting Endpoints to Physical Interface****Step 5: Enable routing on the two interfaces.**

See Figure 4-7.

```

ATLAS 800 Plus/Router/IP/Interfaces
Static Routes
ARP Cache
Routes
Interfaces
          1  Network Name  Address  Subnet Mask  Routing  Resolu
          2  XYZ Network  0.0.0.0  0.0.0.0  Enable  AR
          3  XYZ Network  0.0.0.0  0.0.0.0  Enable  AR

SYS: OK  CSU:ALRM  1: --  2: --  3: --  4: --  5: --  6: --  7: --  8: --
Packet interfaces into the IP routing stack
                                     ^Z=help  0:55

```

**Figure 4-7. Panel for Enabling Routing**



**A-Law**

PCM coding method as defined by the ITU-T. It is a companding standard for converting between analog and digital in a PCM system. A-Law is mainly used in Europe. MU-Law is the North American equivalent.

**ANSI T1.617-D (Annex D)**

See Annex D.

**Annex D**

Standard for frame relay signaling as defined by the American National Standards Institute (ANSI) in publication T1.617-D.

**Annex A**

Standard for frame relay signaling as defined by the International Telecommunication Union Telecommunication in publication Q.933-A.

**ARP**

Address Resolution Protocol. A protocol that maps an IP address to an ethernet MAC address.

**BECN**

Backward Explicit Congestion Notification. Sent to the device generating excessive frame relay traffic as a means to slow down the flow of data to the network. Compare with FECN.

**CIR**

Committed Information Rate. The guaranteed bandwidth available for customer data under normal circumstances.

**DHCP**

Dynamic Host Configuration Protocol. Allows dynamic IP address allocation.

**DID**

Direct Inward Dial. Digits received or transmitted that allow the attached equipment to further route a call.

**Discard Eligible (DE)**

A flag that can be set to indicate to the network that if excess traffic is received this frame can be discarded if necessary.

**DLCI**

Data Link Connection Identifier. Identifies each virtual circuit within a shared physical channel.

**FECN**

Forward Explicit Congestion Notification. Sent to the device receiving data from the frame relay network to indicate that there is congestion in the receive direction. The receiving DTE device should take action to slow down traffic from the remote end. Compare with BECN.

**FRAD**

Frame Relay Access Device. Any equipment that provides a connection between a frame relay network and a LAN.

**Frame Relay**

A subset of the X.25 packet switching protocol that allows for efficient transmission of data by utilizing many virtual circuits on a single physical interface.

**Full Status Poll**

A poll that occurs each N391 polls and reports the status of each PVC. During this poll the frame relay switch can also notify the user side of the UNI of any creation or deletion of frame relay PVCs.

**G.723.1**

ITU-specified voice compression algorithm.

**Group of Four**

The Frame Relay Consortium, composed of Cisco Systems, DEC, Nortel, and StrataCom, which defined an interface for the UNI.

**HDLC**

High Level Data Link Control. A generic link-level communications protocol developed by the International Organization for Standardization (ISO). HDLC manages synchronous code-transparent, serial information transfers over a link connection.

**IAD**

Integrated Access Device. A network access device that provides many services from a single platform. ATLAS is an IAD.

**IARP**

Inverse Address Resolution Protocol. Used for resolving the protocol address when the hardware address is known.

**ICMP**

Internet Control Message Protocol. Specified in RFC-292 to provide diagnostic functions.

**IP**

Internet Protocol. A protocol which provides for transmitting blocks of data between hosts identified by fixed-length addresses.

**ITU-T Q.933-A (Annex A)**

See Annex A.

**IXC**

IntereXchange Carrier. Phone companies that connect LECs.

**LEC**

Local Exchange Carrier. Provides local access to public data and phone networks.

**Link Integrity Poll**

A poll that occurs each T391 seconds to determine the state of the connection to the frame relay switch.

**LLC2**

Logical Link Control Type 2. Upper portion of the Data Link layer (layer 2) that handles flow control and error control.

**LMI**

Standard published by the Frame Relay Consortium in 1990 to create a defined interface on the UNI. The Consortium was composed of Cisco Systems, DEC, Nortel, and StrataCom, and is commonly referred to as the Group of Four. LMI has become a generic term to indicate the type of frame relay signaling used and could be used to mean Annex A or Annex D.

**MAC Address**

Data link address that is unique for every device that gets connected to a LAN. Devices on the LAN use these addresses to update routing tables.

**MU-Law**

A companding standard for converting between analog and digital in a PCM system. MU-Law is mainly used in North America. A-Law is the European equivalent.

**NNI**

A standard interface between two frame relay switches.

**N391**

Defines how many link integrity polls occur before a full status poll. One out of the number defined in N391 is a full status poll. Default is 6.

**N392**

Defines how many bad polls can occur within an N393 window before the link is declared down.

**N393**

Defines the number of polls that make up the window used by N392 to determine if a link is operational.

**OSI**

Open System Interconnection. It is a standard defined by ISO and the ITU-T to allow interoperability between equipment of different vendors.

**Packet**

A transmission that contains both control information and data.

**Packet Endpoint**

A virtual port within ATLAS that a specified physical port terminates its data into for further routing by the system.

**Packet Switching**

A method of routing packets that avoids congestion and minimizes delivery time.

**PCM**

Pulse Code Modulation. The most common method for encoding analog voice into a digital bit stream.

**PVC**

Permanent Virtual Circuit. Virtual circuit within the frame relay network that has all bandwidth parameters permanently defined upon ordering the circuit.

**QOS**

Quality of service. A means of guaranteeing available bandwidth under normal operating conditions.

**RIP**

Routing Information Protocol. A protocol used to exchange routing information among a set of computers connected by a LAN. RIP uses hop count as a routing metric.

**Router**

An interface which finds the best path between two networks. Routers forward packets from one network to another, based on network layer information.

**Routing Metric**

The method by which a routing algorithm determines that one route is better than another. This information is stored in routing tables. Such tables include reliability, delay bandwidth, load, MTUs, communication costs, and hop count.

**SNA**

Systems Network Architecture. Network architecture developed by IBM in the 1970s.

**SVC**

Switched Virtual Circuit. Virtual circuit within the frame relay network that is created only when needed. Bandwidth parameters are defined each time the circuit is created.

**T391**

Defines the time in seconds between frame relay link integrity polls.

**T392**

Defines the time in seconds the frame relay switch will wait for a poll from the user before declaring the poll bad.

**TBOP**

Transparent Bit Oriented Protocol. ADTRAN proprietary method for transmitting HDLC traffic across a frame relay network.

**Transparent BOP**

See TBOP

**TCP**

Transmission Control Protocol. Connection oriented protocol that provides error control of IP traffic.

**TIA 464A**

Telecommunication Industry Association's standard for DTMF detection and generation.

**UDP**

User Datagram Protocol. Connectionless protocol defined by RFC 768 for transmission of data without acknowledgment or error control.

**UNI**

User to Network Interface. Defines the interface between the CPE and the frame relay providers switch.

**Voice Compression**

A means of reducing the bandwidth required for transmission of voice traffic with minimal impact on the quality of the voice.



## Numerics

10BaseT Ethernet port 1-1

## A

address resolution protocol (ARP) cache 3-4  
ARP (address resolution protocol) cache 3-4

## C

configuration examples 4-1  
configuring router interfaces 3-7  
configuring router options 3-2  
configuring routing functions 3-1  
contents of route table 3-5  
creating routes 3-3

## D

defining gateway interface 3-4  
defining IP address 3-3  
defining IP address of receiving router 3-4  
defining method of sending RIP route advertisements 3-9  
defining number of router hops 3-4  
defining periodic updates 3-9  
defining router options 3-2  
defining triggered updates 3-9  
deleting routes 3-3

## E

examples, configuration 4-1  
exchanging routing information 2-1

## F

far-end address 3-8  
flags 3-6

## H

hop count 2-1  
hops, number of 2-1

## I

individual interface IP address 3-7  
inverse ARP 3-8  
    disabled 3-8  
    enabled 3-8  
IP menu 3-3  
    ARP cache 3-4  
        interface 3-5  
        IP address 3-4  
        MAC address 3-4  
        time 3-4  
        Tx pending 3-5  
        type 3-4  
    interfaces 3-7  
        address 3-7  
        far-end address 3-8  
        IARP 3-8  
        MTU 3-8  
        network name 3-7  
        RIP 3-8  
            method 3-9  
            mode 3-8  
            protocol 3-8  
            updates 3-9  
            V2 method 3-9  
        subnet mask 3-7  
    routes menu 3-5  
        flags 3-6  
        gateway 3-5  
        hops 3-6  
        interface 3-6  
        IP address 3-5  
        netmask 3-5  
        TTL 3-6  
        used 3-6  
    static routes 3-3  
        gateway 3-4  
        hops 3-4  
        interface 3-4  
        IP address 3-3  
        netmask 3-3  
IP routing 2-1

route discovery 1-2

## L

layer 3 of OSI model 2-1

## M

managing static IP routes 3-3

menu tree 3-2

menus, IP 3-3

ARP cache 3-4

interface 3-5

IP address 3-4

MAC address 3-4

time 3-4

Tx pending 3-5

type 3-4

interfaces 3-7

address 3-7

far-end address 3-8

IARP 3-8

MTU 3-8

network name 3-7

RIP 3-8

method 3-9

mode 3-8

protocol 3-8

updates 3-9

V2 secret 3-9

subnet mask 3-7

routes 3-5

flags 3-6

gateway 3-5

hops 3-6

interface 3-6

IP address 3-5

netmask 3-5

TTL 3-6

used 3-6

static routes 3-3

gateway 3-4

hops 3-4

interface 3-4

IP address 3-3

netmask 3-3

modifying routes 3-3

monitoring

IP routes 3-3

router interfaces 3-7

router options 3-2

## N

number of bits used in address 3-3

## O

OSI model, layer 3 2-1

## P

path, selecting criteria for 2-1

poison reverse 3-9

## R

remote connectivity, providing 3-1

resolving ethernet address 3-4

RIP (routing information protocol) 2-1

route

discovery 1-2

unreachable 2-1

route table, contents 3-5

router

external to integral conversion 1-1

features 1-2

interface name 3-7

menu 3-1

menu tree 3-2

overview 1-1

specifications 1-2

routing

information protocol 2-1

IP 2-1

number of hops 2-1

preferred route 2-1

process 2-1

## S

setting protocol version of RIP 3-8

split horizon 3-9

static IP routes, managing 3-3

subnet mask 3-7

## T

terminal menu structure 3-1

## U

unreachable route 2-1

updates 3-9

using RIP V2 3-9

using router menu to configure routing functions 3-1

## V

V2 secret 3-9



# Product Support Information

## Presales Inquiries and Applications Support

Please contact your local distributor, ADTRAN Applications Engineering, or ADTRAN Sales:

Applications Engineering (800) 615-1176

Sales (800) 827-0807

## Post-Sale Support

Please contact your local distributor first. If your local distributor cannot help, please contact ADTRAN Technical Support and have the unit serial number available.

Technical Support (888) 4ADTRAN

## Repair and Return

If ADTRAN Technical Support determines that a repair is needed, Technical Support will coordinate with the Customer and Product Service (CAPS) department to issue an RMA number. For information regarding equipment currently in house or possible fees associated with repair, contact CAPS directly at the following number:

CAPS Department (256) 963-8722

Identify the RMA number clearly on the package (below address), and return to the following address:

ADTRAN Customer and Product Service  
6767 Old Madison Pike  
Building #6 Suite 690  
Huntsville, Alabama 35807

RMA # \_\_\_\_\_